

Novel Pre-treatment for Lignocellulosic Biomass Delignification Using Alkaline-Assisted Ohmic Heating

Izzah Farhana Ab Aziz¹, Hasfalina Che Man^{1,2*}, Muhammad Hazwan Hamzah^{1,2}, Nur Syakina Jamali³ and Rozita Omar³

¹Department of Biological and Agricultural Engineering, Faculty of Engineering, Universiti Putra Malaysia, 43400 UPM, Serdang, Selangor, Malaysia

²SMART Farming Technology Research Centre, Faculty of Engineering, Universiti Putra Malaysia, 43400 UPM, Serdang, Selangor, Malaysia

³Department of Chemical and Environmental Engineering, Faculty of Engineering, Universiti Putra Malaysia, 43400 UPM, Serdang, Selangor, Malaysia

ABSTRACT

Lignocellulosic biomass (LCB) is a common substrate for biogas and bioethanol production due to its significant properties and abundance. However, it has a unique recalcitrant structure that can inhibit the production of biogas, which necessitates pre-treatment of the substrate to obtain higher cellulose or sugars ready for microbial hydrolysis in producing biogas. In this study, a novel approach for empty fruit bunch (EFB) pre-treatment has been made: ohmic heating pre-treatment. This method is conventionally used in the food industry for pasteurization and extraction. It involves electric current and resistance inside the material that releases heat (Joule effect). A preliminary study has been done to figure out the potential of alkaline assisted with ohmic heating (AA-OH) pre-treatment for EFB. Lignin reduction for AA-OH EFB is higher than EFB that undergoes only size reduction (SR) pre-treatment, which are 15.54% and 11.51%, respectively. After confirming the potential of ohmic heating as one of the pre-treatment methods for EFB, three

parameters were investigated (reaction time, temperature, and solvent concentration) by one factor at a time (OFAT) testing to obtain the optimum condition for AA-OH pre-treatment. The optimal condition for achieving a high reduction in lignin (86.9%) and hemicellulose (75%) while also showing a significant increase in cellulose (63.2%), which is desirable for the fermentation process, is achieved by using 4% w/v of

ARTICLE INFO

Article history:

Received: 14 November 2022

Accepted: 04 April 2023

Published: 09 October 2023

DOI: <https://doi.org/10.47836/pjst.31.6.22>

E-mail addresses:

izzahfarhana95@gmail.com (Izzah Farhana Ab Aziz)

hasfalina@upm.edu.my (Hasfalina Che Man)

hazwanhamzah@upm.edu.my (Muhammad Hazwan Hamzah)

syakina@upm.edu.my (Nur Syakina Jamali)

rozitaom@upm.edu.my (Rozita Omar)

* Corresponding author

NaOH, ohmic-heated at a temperature of 120°C for 25 minutes. To sum up, this developed ohmic heating pre-treatment technique can be applied to LCB prior to biogas or bioethanol production.

Keywords: Biogas, empty fruit bunch (EFB), lignocellulosic, ohmic heating, pre-treatment, recalcitrant

INTRODUCTION

Exploration of alternative sustainable energy sources is actively carried out by researchers worldwide out of concern for the scarcity of conventional energy resources such as coal, petroleum, and others (Diyanilla et al., 2020). In addition to that, the increasing world population and high demand for energy consumption are also the main concerns (Hoekstra & Wiedmann, 2014). Agricultural waste is mainly comprised of lignocellulosic biomass wastes, considered a cheap source for renewable biogas production, and has excellent potential to overcome the spike in energy demand in the future. As the second largest crude palm oil (CPO) producer and exporter (Ezechi & Muda, 2019), Malaysia also generates abundant oil palm waste, estimated to be more than 80 million tons annually. Palm oil plantation has become one of Malaysia's emerging main agricultural sectors, making the country recognizable in the world as one of the biggest palm oil producers. Significant production of palm kernel shell (PKS), an oil palm frond (OPF), mesocarp fiber (MF), empty fruit bunch (EFB), and palm oil mill effluent (POME) are by-products of the processing of palm oil production.

EFB is chosen in this study due to its lignocellulosic properties, which are highly obtainable, excellent compositional characteristics, and huge biogas production potential. It is a lignocellulosic material consisting mainly of cellulose and hemicellulose (about 80%), made of sugars that can be fermented and converted into biogas (Palamae et al., 2017). However, lignocellulosic biomass (LCB) has uniquely structured lignin, making it recalcitrant towards microbial activity or enzymatic hydrolysis during fermentation or biogas production. Cellulose, the complex lignin-hemicellulose bond, hinders the main component for biofuel generation due to its high molecular weight, branched amorphous compound, and substituted polymer (Karunakaran et al., 2020). Therefore, selecting suitable pre-treatment methods is intrinsic to enhancing biofuel production at a low cost on processing and environmentally friendly.

Alkaline pre-treatment of EFB is already proven to be one of the excellent options among other chemical methods. They are less caustic than dilute acid and can be performed at ambient pressure, eliminating the need for specialized equipment that is corrosion-resistant, or that can withstand high pressures. Several alkaline reagents commonly used are hydroxides of sodium, potassium, calcium, and ammonium (Baruah et al., 2018), of which sodium hydroxide (NaOH) was the most effective (Kim et al., 2016). Cleavage

of the intermolecular ester linkages between lignin and hemicellulose resulted from the saponification reaction, which then allows the alkaline solution to solubilize both fragments (Hu & Ragauskas, 2012; Sun et al., 2016). The degradation of cellulose cell walls will allow for more enzyme interaction (Varga et al., 2003). This pre-treatment can also reduce the crystallinity and degree of polymerization of EFB by cellulose swelling, which increases the internal surface area (Baruah et al., 2018; Behera et al., 2014). Another main benefit of this method is that it requires only mild pre-treatment conditions with minimal inhibitor production and sugar degradation (Alvira et al., 2010; Xu et al., 2010; Zhao et al., 2008). However, this pre-treatment method is usually paired with other methods to shorten its processing time and reduce the usage of chemical and energy input (Conde-Mejía et al., 2012).

The utilization of ohmic heating in LCB pre-treatment is still novel and not yet explored despite its excellent potential in food processing (Rodríguez et al., 2021; Perasiriyan et al., 2016; Pires et al., 2020; Ríos-Ríos et al., 2021; Sengun et al., 2014; Wang et al., 2021). The state-of-the-art OH utilization emerging in the last 15 years, comprehensively included in the extraction process of essential oil (Karunanithi, 2019; Sofi'I et al., 2021; Tunç & Koca, 2021), food-grade (Gavahian et al., 2015; Pare et al., 2014), phytochemicals (Pereira et al., 2016), and phenolic compounds (Kutlu et al., 2021). Ohmic heating is one of the electro-heating methods successfully developed from conventional heating (Aurina & Sari, 2022; Lee & Jun, 2011). Also known as Joule, direct electrical, resistance, electro-heating, and electroconductive heating (Indiarto & Rezaharsanto, 2020; Perasiriyan et al., 2016; Sastry, 2008), alternating electric current (AC) electric fields are passed through materials. Hence, evolving from a single conventional pre-treatment process, researchers explored integrating pre-treatment methods simultaneously into combinations of two or more processes (Hassan et al., 2018; Ummalyima et al., 2019).

The most favored methods in trend for EFB pre-treatment are acid/alkaline-assisted microwave heating which combines the physical (microwave heating) and chemical pre-treatments, where chemical solvents used such as sodium hydroxide, NaOH (Hamzah et al., 2020; Nomanbhay et al., 2013; Yaser et al., 2017), sulphuric acid, H₂SO₄ (Akhtar et al., 2015; Fatriasari et al., 2017) and ferric (III) chloride, FeCl₃ (Hassan et al., 2021). Electrochemical (EC) pre-treatment is also categorized as one option for 'greener' alternative technologies for delignification (Tamburini et al., 2011) and has started to venture into the reduction in the recalcitrance of LCB (Panigrahi et al., 2021). 64% lignin reduction in wheat straw was obtained by Tamburini et al. (2011) using hypochlorous acid (HOCl) as an electrolyte, and 46% reduction for yard waste using NaOH, done by Panigrahi et al. (2021). At the same time, Sun et al. (2020) incorporated this EC method into organosolv pre-treatment with 73% delignification of sawdust. EC pre-treatment applies a direct current to the system by the principle of electrophoresis, ohmic heating, and electro-osmosis with the aid of chemical reagents as electrolytes for electron transfer

mediators (Panigrahi & Dubey, 2019; Rochefort et al., 2004). Particles will be disintegrated where organic matter solubilization happens due to bonds breaking among polymers in the LCB (Panigrahi & Dubey, 2019).

In this study, ohmic heating is chosen as the pre-treatment method to be assisted with alkaline reagents as electrolytes. The potential of AA-OH to delignify EFB structures was investigated and compared with the performance of SR. Following that, optimization of parameters for AA-OH was also carried out for optimum EFB delignification and cellulose recovery. OFAT approach allows researchers to explore a wide range of values, providing a rough estimation of the optimal levels for a particular factor (Hu et al., 2016) without considering the interactions between different factors. It can help identify which factors have the most significant impact on the outcome variable and which ones can be ignored, especially for this novel study. These pre-treatment method combinations are more economical and environmentally friendly by reason of a reduction in the number of operational steps. Moreover, they also demonstrated an excellent delignification efficiency of feedstock (Diyaniilla et al., 2020) for biogas production while minimizing the presence of inhibitors that can interrupt the performance of biogas production (Kumar & Sharma, 2017; Zhai et al., 2018).

MATERIALS AND METHODS

Preparation of Samples

Freshly processed EFB was collected from Seri Bandar Palm Oil Mill (Banting, Selangor, Malaysia). The shredded EFB were then separated from debris and kernel shell before being dried in a drying oven at 50°C for 24 hours to reach a moisture content of less than 10% (Simanungkalit et al., 2017) for fungal proliferation prevention (Marçal et al., 2018). After drying, the EFB was cut and sieved into desired particle sizes (0.5 mm and 1-2 mm) and kept in a proper storage container at room temperature until further use.

Ohmic Heater Design and Fabrication

The ohmic heater used in this study was designed and fabricated by Hamzah et al. (2011) for the delignification of LCB at a lab scale, which consisted of a 1 L size cylindrical process chamber with a maximum 800 mL holding capacity, fixed with a pair of titanium electrodes in the process chamber. The main compartments of the ohmic heater consist of an ohmic heated cell, a power supply (transformer), and a temperature sensor. The electrodes are connected to a single-phase alternating current step-down transformer with a 3kW power supply rated at 15 kVA with a maximum working current of 10 A. The electrical energy is converted into thermal energy, and the heat generated is distributed evenly inside the treated materials. With almost 100% energy transfer efficiency, the resulting energy instigates

temperature rise in the system (Gavahian et al., 2019; Lee & Jun, 2011; Picart-Palmade et al., 2019; Shim et al., 2010).

The main advantage of ohmic heating (OH) over conventional and microwave heating (MW) is widely known for its short time of the treatment process, which demonstrated high efficiency in both processing time and heating rate (Alkanan et al., 2021; Gavahian et al., 2019; Lee et al., 2013; Pires et al., 2020; Sakr & Liu, 2014). Less energy consumption with better quality products makes the OH system highly efficient in energy usage, especially compared to microwave and other high-pressure processes (Pires et al., 2020; Rinaldi et al., 2020). In food pasteurization, the thermal effects combined with electric effects can increase cell membrane permeability and destroy bacterial cells (Cappato et al., 2017). Figure 1 shows the design and fabrication of the ohmic heater from the schematic diagram (a) to the fabrication of the ohmic heater (c). From the computer-aided design front view of ohmic heater (b), parts stated are 1: ohmic switch, 2: input power, 3: main switch, 4: ohmic power, 5: temperature controller, 6: ohmic voltage selector, 7: single-phase transformer behind the main cover, 8: ohmic cell, 9: titanium electrode, and 10: thermocouple probe.

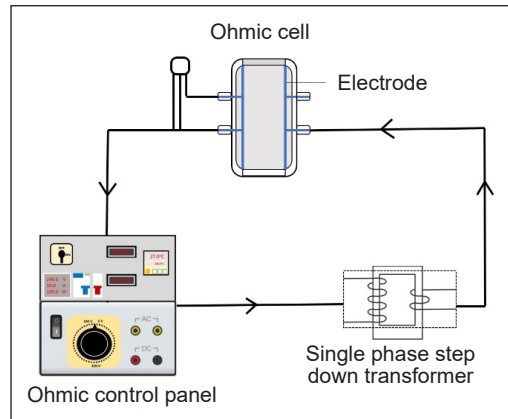

(a)

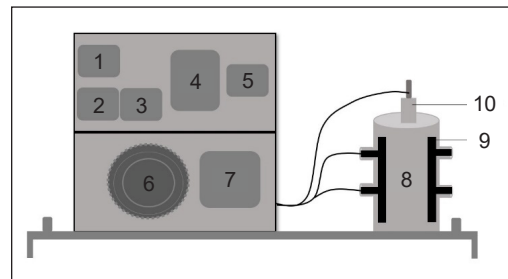

(b)



(c)

Figure 1. Design and fabrication of ohmic heater: (a) schematic diagram of ohmic heater; (b) computer-aided design front view ohmic heater; and (c) fabricated ohmic heater

Pre-treatment of EFB

A complete series of tests was done to study the potential of ohmic heating pre-treatment on the EFB delignification by comparing the effect of size reduction (SR) and alkaline-assisted ohmic heating (AA-OH) pre-treatment on the composition of cellulose, hemicellulose, and lignin for untreated and pre-treated EFB. Prior to the ohmic heating process, 7 g of prepared native EFB was soaked in 700 mL of 1% w/v sodium hydroxide (NaOH) for 2

hours. This step was necessary to let the fibrous EFB sample absorb the liquid until its equilibrium state. Then, the sample mixture was transferred into the ohmic cell and ohmic heated for 5 minutes at 80°C at a fixed solid-to-liquid ratio of 1:100. The determination of chemical composition for native, size reduced, and ohmic heated EFB was carried out using the Technical Association of the Pulp and Paper Industry (TAPPI) method to see if there was any significant potential for ohmic heating pre-treatment (Hamzah et al., 2020; Mohammad et al., 2020). From the result, further optimization of AA-OH parameters on EFB was done accordingly to one factor at a time (OFAT) for three different variables such as reaction time (5–25 mins), temperature (80–120°C), and concentration of NaOH (1–5% w/v).

Morphological and Compositional Analysis of EFB

Morphological studies to observe the changes of untreated and pre-treated EFB were done by using a Scanning Electron Microscope (SEM), S-3400N model (Hitachi, Japan) equipped with an Energy Dispersive Spectroscopy (EDS) system. The samples were dried in a drying oven at 60°C for 24 hours before undergoing gold coating by a sputtering process, which was done to avoid the charging effect during SEM analysis to ensure their low moisture content. The analysis of morphological changes in the lignin structure of the fibrous sample was recorded at 25 kV acceleration voltage for 250× magnification with a working distance (WD) of 6.3 to 6.4 mm. 5 g of EFB samples were prepared and dried before compositional analysis. TAPPI standard methods (TAPPI, 1950) were followed in the determination of lignin (T-222), holocellulose (T-249-75), and α -cellulose (T-203) content in all untreated and pre-treated EFB samples. At the same time, hemicellulose content was obtained by subtracting the content of α -cellulose from the holocellulose.

RESULTS AND DISCUSSION

Physical And Morphological Changes of Pre-treated EFB

Native EFB originally comprises 24–65% cellulose, 17–34% hemicellulose, and 13–37% lignin (Khalil et al., 2012; Chang, 2014; Palamae et al., 2017; Yimlamai et al., 2021). In this work, the chemical compositions of native EFB obtained were comparable to the reported ranges of 22% cellulose, 32% lignin, and 36% hemicellulose. The composition of EFB may vary as this substrate is a natural plant fiber, mainly due to the maturity and freshness level of the empty bunch collected for recovery as well as the geographic factor of the plantation site (Palamae et al., 2017). Figure 2 shows the differences in the physical appearance of the size-reduced EFB (b) and alkaline-assisted ohmic heated EFB (c) compared to the untreated native EFB (a). After the severe grinding process, the size color reduced EFB has gone darker in its powdery form due to the friction created during grinding, resulting in heat generation. The color was slightly lighter for the ohmic-heated EFB, becoming more brittle than its original form.

Morphological and structural changes of pre-treated and untreated EFB were analyzed using Scanning Electron Microscopy (SEM), as shown in Figure 3. Morphologically, one peculiar characteristic can be observed in native EFB, where this fiber has a higher rigidity index than other fibrous plant types, mainly due to its thick cell wall, which is much like the structures of wood cell walls compared to other types of plant cells. From the SEM image results, Figure 3(a), the raw fiber had a relatively smooth surface from the lignin or wax layer cover that protected it from rupture. On the other hand, both pre-treatments significantly altered the fiber morphology and caused some structural damage. Extreme

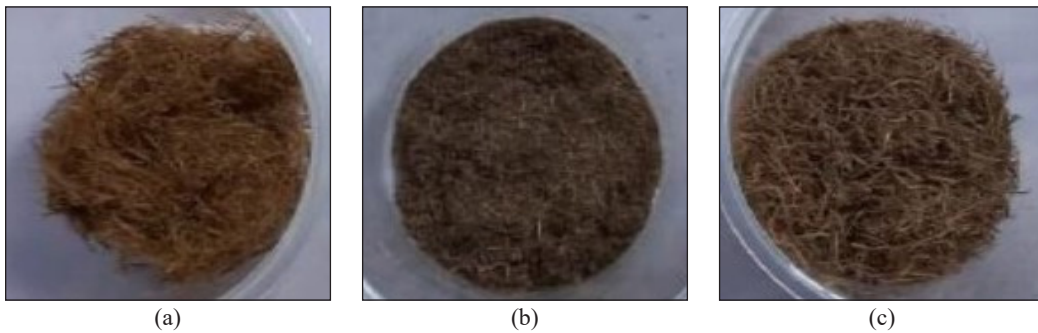

Figure 2. Physical appearances: (a) native EFB; (b) SR-EFB; and (c) AA-OH EFB

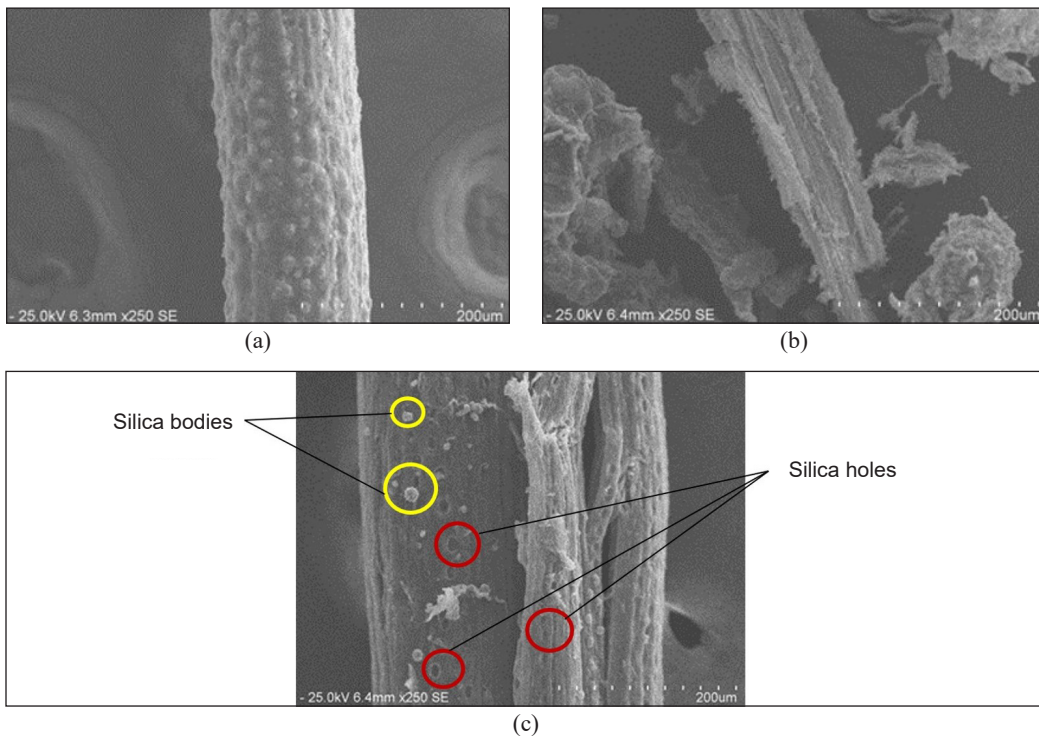

Figure 3. SEM images under 250 \times magnification: (a) native EFB; (b) SR EFB; and (c) AA-OH EFB

size reduction of the EFB led to the tearing of the fiber wall surrounding the cellulose and hemicellulose components, as seen in Figure 3(b). This tearing or fracturing increases the surface area of EFB, which exposes more cellulose and hemicellulose to the subsequent pre-treatment processes. At the same time, a significant effect can be seen after the alkaline-assisted ohmic-heating (AA-OH) process, as in Figure 3(c). Most of the outer layer of lignin was deteriorated and eliminated (Palamae et al., 2017; Azelee et al., 2014) where the cell walls were shattered, and lignin and cellulose were hydrolyzed, creating pores (Iberahim et al., 2013).

Pores formed when pre-treatment using sodium hydroxide (NaOH) formed silica holes (Hamzah et al., 2020), as most of the silica components were removed with extractives on the EFB surface. Removing silica is crucial (Głazowska et al., 2018) because it may create precipitation of insoluble compounds, contributing to biomass recalcitrance. As the silica is deposited in the cell wall, it will protect the plant from enzymatic hydrolysis and microbial attack, acting as one of the physical barriers for fiber, which can cause problems during biomass utilization for bioenergy production (Hamzah et al., 2020; Le et al., 2015). Furthermore, after removing the lignin surfaces of the fiber, circular silica bodies were revealed to be deposited on the surfaces (Palamae et al., 2017). Hence, AA-OH pre-treatment was managed by exposing the cellulose fibers and removing several inter-fiber materials, which opened spaces between the cellulose. It allowed better contact of cellulose to microbial or hydrolytic enzyme activity for an increment of glucose and biogas yield.

Lignocellulosic Composition of Untreated and Pre-treated EFB

The compositional analysis of native, size-reduced (SR), and alkaline-assisted ohmic heated (AA-OH) EFB was determined for lignin, cellulose, and hemicellulose content by using the TAPPI method. The native EFB was prepared accordingly at a particle size ranging from 1 to 2 mm, whereas further size reduction of less than 0.5 mm was done for the SR EFB samples. The EFB samples (1–2 mm) were treated at 300 W of ohmic heating for 5 minutes at 80°C for AA-OH pre-treatment. The electrolyte solvent used was 1% w/v NaOH with a solid-to-liquid ratio of 1:100. After the ohmic heating pre-treatment, the ohmic cell was allowed to cool down first, then de-attached from the electrodes' connecting. The slurry was then filtered through Whatman filter paper No. 1 and washed with distilled water to neutralize the sample. After sample drying at 60°C for 24 hours, the pre-treated samples were stored at room temperature for further analysis.

From the chemical compositional analysis, as shown in Table 1, native EFB comprised lignin (23%), hemicellulose (36%), and cellulose (32%). Another 8% was comprised of extractives and other removal components in the sample. The results obtained were in the ranges found in the literature, which were 15%–30% lignin, 20%–45% hemicellulose, and 20%–65% cellulose (Hamzah et al., 2020; Krishnan et al., 2017; Mohammad et al.,

Table 1
Chemical composition of native EFB and pre-treated EFB

Components (w/w) %	Native EFB	SR EFB	AA-OH EFB
Extractives	4.23	4.11	4.1
Lignin	22.85	20.22	19.30
Hemicelluloses	36.45	34.40	33.98
Cellulose	32.15	36.48	35.78
Removal (others)	4.32	4.79	6.85

2020; Wadchasit et al., 2020). The holocellulosic component in the EFB was the highest by combining the portion of hemicellulose and cellulose (68%). It proved that EFB is one of the perfect substrates for biogas production. On the other hand, the amount of lignin was comparable to the lignin content of hardwoods, which was in the range of 15%–30% (Lourenço & Pereira, 2018; Tarasov et al., 2018) and considered to be high, which necessitates pre-treatment before being utilized as a substrate for biogas production.

From the initial study to investigate the ability of AA-OH pre-treatment on EFB delignification, chemical composition analysis, as in Table 1, has shown a significant positive effect. After SR pre-treatment, it was observed that reducing the particle size of EFB would lead to degradation of both lignin (1.1-fold decrease) and hemicellulose (1.0-fold decrease) content compared to Native EFB. Meanwhile, cellulose composition increased by 1.1-fold. The reduction of EFB's particle size led to a decrease in its polymerization degree and crystalline structure of EFB (Diyanilla et al., 2020). Following that, the surface area of the substrate was increased (Mohammad et al., 2020), which would assist in more efficient enzymatic and microbial hydrolysis (Nabilah-Jansar et al., 2018). However, the cost of this size reduction for feedstock is quite expensive due to the notably high usage of energy for machinery operation, especially in large-scale utilization (Baruah et al., 2018; Cardona et al., 2018; Nabilah-Jansar et al., 2018).

A higher reduction in lignin composition was observed for EFB pre-treated with AA-OH, at a 1.2-fold reduction (19.3%), followed by SR (20.2%), compared to its original lignin content, which was 22.9%. In a similar situation for hemicellulose content, AA-OH reduced the component further than SR pre-treatment, with about a 1.1-fold reduction from 36.5% to 33.98% and 34.40%, respectively. At the same time, the composition of cellulose was increased in the pre-treated EFB for SR and AA-OH, which went up to 36.48% (1.1-fold increase) and 35.78%, respectively. The lignin and hemicellulose reduction and cellulose increment of the EFB after AA-OH pre-treatment are comparable to the SR pre-treatment. Even though there was no significant difference in lignin, hemicellulose, and cellulose content after both pre-treatments, the result still showed that even under mild conditions of treatment and without reducing the size of the substrate, AA-OH has good potential

as a new pre-treatment method for EFB delignification. Hence, AA-OH parameters were optimized to find out the optimum condition for high delignification of EFB.

One Factor at A Time (OFAT) optimization approach was selected as the initial methodology for examining and validating the range of values assigned to each parameter under investigation in the delignification process of EFB. The parameters selection and value range for set parameters were referred to another delignification method, microwave-assisted alkaline pre-treatment. Microwave-assisted alkaline delignification is a process that uses microwave irradiation and alkaline solutions to remove lignin from lignocellulosic biomass (Irmak et al., 2018). The process involves treating the EFB with an alkaline solution, followed by exposure to microwave radiation. The microwave radiation causes the alkali solution to heat up rapidly and efficiently penetrate the biomass, resulting in the breakdown of lignin and the release of hemicellulose and cellulose (Alexander et al., 2020). Nomanbhay et al. (2013) obtained 74% of lignin removal by microwave-assisted alkaline pre-treatment on EFB at 12 minutes of reaction time with 3% of NaOH used. Ying et al. (2014) required 60 minutes of reaction time using 2% NaOH solution at 120°C to achieve 42% of lignin removal. Another study by Hamzah et al. (2020), showed an increment in the cellulose composition of EFB after microwave-assisted alkaline pre-treatment from 37% to 49% of cellulose at 120°C for 1 hour reaction time, with 4% NaOH concentration.

Hence, for this study, three factors for alkaline-assisted ohmic heating were selected: reaction times, F1 (5–25 mins), temperature, F2 (80–120°C), and concentration of NaOH, F3 (1–5 % w/v). The good ohmic heating condition depends mainly on the heat generation rate, system design, the electrical conductivity of the substrate used, electrical field strength, and treatment time (Timsit & Lutten, 2016). It was found that at EFB pre-treated using AA-OH at 300 W, 120°C for 25 minutes had the highest lignin (86.9%) and hemicellulose (75%) removal with the highest cellulose increment (63.2%), as represented in Figure 4. However, at a concentration of 3% w/v of NaOH, significant lignin and hemicellulose removal was already significant enough to utilize a moderate percentage of an alkaline reagent in EFB pre-treatment.

This AA-OH showed better results than past studies using alkaline-assisted microwave heating (AA-MH). Akhtar et al. (2015) pre-soaked EFB in 8% v/v of sulphuric acid, H₂SO₄, then the slurry was autoclaved for an hour and followed with AA-MH using 2.5M NaOH solution, microwaved at 10000W, 110°C for 90 minutes. The method managed to remove only 72% of lignin content. Pre-treated EFB using AA-MH with 1% w/v NaOH at 550W microwave power for 12.5 minutes, successfully removing 59% of lignin (Fatriasari et al., 2017). The study revealed that extending the reaction time beyond 25 minutes and increasing the temperature beyond 120°C resulted in the highest removal of lignin and hemicellulose and an expected increase in cellulose yield. However, to gain further insight into the limitations of each parameter in EFB delignification, the study

will be further optimized using the Response Surface Methodology (RSM) optimization method. This approach will enable a more comprehensive analysis of outliers within the designated parameter range.

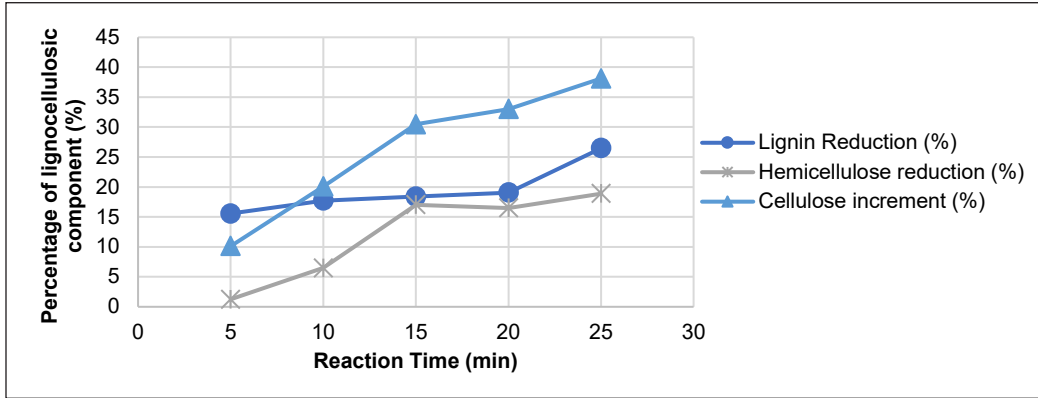

(a)

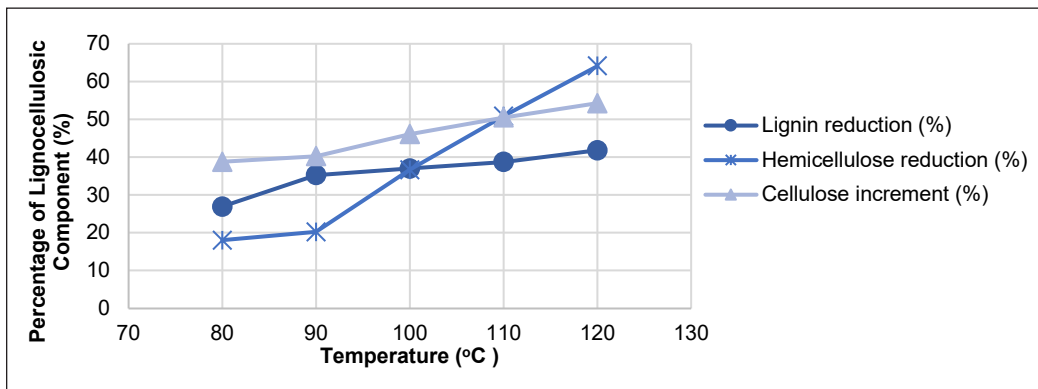

(b)

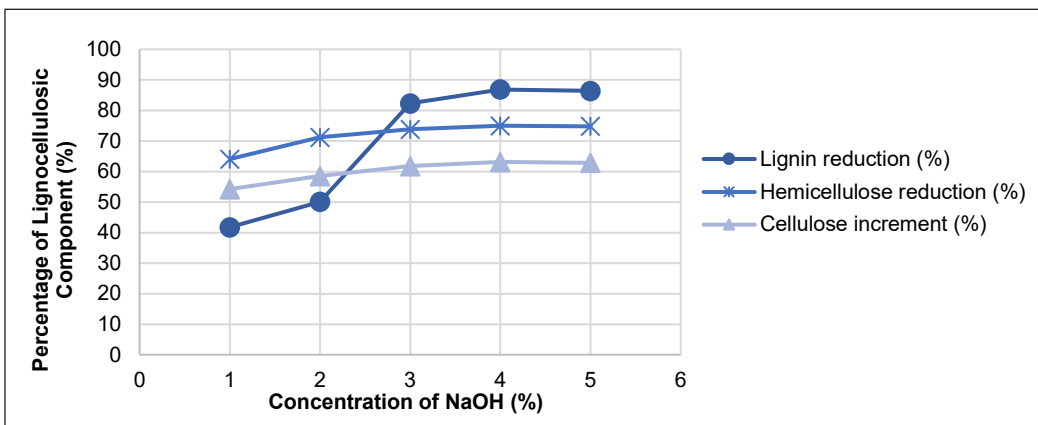

(c)

Figure 4. Lignocellulosic composition of OFAT optimization for AA-OH EFB by parameters of: (a) reaction time; (b) temperature; and (c) concentration of NaOH

When the alternating electric (AC) current passes through the EFB samples, it causes the ions in the electrolyte (NaOH) to move towards electrodes with opposite charges (Alkanan et al., 2021; Aurina & Sari, 2022). The ions will collide among them, causing them to be restricted from moving, thereby increasing kinetic energy in the system and generating heat instantly and volumetrically inside the lignocellulosic structure of EFB. The longest residence time (25 minutes) of EFB showed higher lignin reduction (26.5%) even at low temperatures (80°C) and low NaOH concentration. The long contact time of EFB with the electric current that passes through it at constant temperature will enhance the rupture of lignin and hemicellulose structure, producing higher cellulose content. The heat generated depends on the current induced by the field's voltage gradient and the substrate's electrical conductivity (EC). Whereas EC increases with the presence of ionic substances (Bhagwan et al., 2019; Ozkan et al., 2019; Zhuiykov, 2018), thus explaining the high lignin and hemicellulose removal at high NaOH concentrations due to high electrical conductivity. Therefore, heat and kinetic energy generation will increase the system's temperature.

At a higher temperature (120°C), while keeping the ohmic heating power and time constant at 300W and 25 minutes, respectively, results obtained demonstrate better cellulose production (54%) and removal of lignin (42%) and hemicellulose (64%). AC power is utilized in the ohmic heater, so the heating occurs continuously (Aurina & Sari, 2022). OH involves internal mass heating, where heat is generated and transferred from the internal treated medium into the system, which differs from conventional heating in that heat is transferred from the device into the medium (Hamzah et al., 2020). Therefore, such rapid, intense internal heating caused the rupture of the lignocellulosic structure, which allowed more access for cellulose solubilization by alkaline reagent, disrupting the crystalline structure (Akhtar et al., 2015).

CONCLUSION

In conclusion, AA-OH pre-treatment is suitable for the delignification of EFB with high lignin and hemicellulose removal and high cellulose recovery. Morphological and lignocellulosic compositional analysis of pre-treated EFB showed positive results with significant lignin reduction even at low pre-treatment conditions. These method combinations are more economical and environmentally friendly by reason of a reduction in the number of operational steps. Moreover, they also demonstrated an excellent delignification efficiency of feedstock. This study will be further developed to optimize processing parameters using Response Surface Methodology (RSM), analysis for reducing sugar, and inhibitors for biogas production by anaerobic digestion and dark fermentation process.

ACKNOWLEDGMENTS

The authors would like to acknowledge the Department of Biological and Agricultural Engineering, Faculty of Engineering UPM, and Malaysia Ministry of Higher Education (MOHE) for the financial and laboratory support through the grant of the Fundamental Research Grant Scheme [FRGS/1/2020/TK0/UPM/02/7].

REFERENCES

- Akhtar, J., Teo, C. L., Lai, L. W., Hassan, N., Idris, A., & Aziz, R. A. (2015). Factors affecting delignification of oil palm empty fruit bunch by microwave-assisted dilute acid/alkali pretreatment. *BioResources*, *10*(1), 588-596.
- Alexander, R. A., Innasimuthu, G. M., Rajaram, S. K., Jeganathan, P. M., & Somasundarar, S. C. (2020). Process optimization of microwave-assisted alkali pretreatment for enhanced delignification of *Prosopis juliflora* biomass. *Environmental Progress and Sustainable Energy*, *39*(1), Article 13289. <https://doi.org/10.1002/ep.13289>
- Alkanan, Z. T., Altemimi, A. B., Al-Hilphy, A. R. S., Watson, D. G., & Pratap-Singh, A. (2021). Ohmic heating in the food industry: Developments in concepts and applications during 2013-2020. *Applied Sciences*, *11*(6), Article 2507. <https://doi.org/10.3390/app11062507>
- Alvira, P., Tomás-Pejó, E., Ballesteros, M., & Negro, M. J. (2010). Pretreatment technologies for an efficient bioethanol production process based on enzymatic hydrolysis: A review. *Bioresource Technology*, *101*(13), 4851-4861. <https://doi.org/10.1016/j.biortech.2009.11.093>
- Aurina, K., & Sari, A. (2022). Ohmic heating: A review and application in food industry. *Advances in Biological Sciences Research*, *19*, 107-113.
- Azelee, N. I. W., Jahim, J. M., Rabu, A., Murad, A. M. A., Bakar, F. D. A., & Illias, R. M. (2014). Efficient removal of lignin with the maintenance of hemicellulose from kenaf by two-stage pretreatment process. *Carbohydrate Polymers*, *99*, 447-453. <https://doi.org/10.1016/j.carbpol.2013.08.043>
- Baruah, J., Nath, B. K., Sharma, R., Kumar, S., Deka, R. C., Baruah, D. C., & Kalita, E. (2018). Recent trends in the pretreatment of lignocellulosic biomass for value-added products. *Frontiers in Energy Research*, *6*, Article 141. <https://doi.org/10.3389/fenrg.2018.00141>
- Behera, S., Arora, R., Nandhagopal, N., & Kumar, S. (2014). Importance of chemical pretreatment for bioconversion of lignocellulosic biomass. *Renewable and Sustainable Energy Reviews*, *36*, 91-106. <https://doi.org/10.1016/j.rser.2014.04.047>
- Bhagwan, J., Kumar, N., & Sharma, Y. (2019). Fabrication, characterization, and optimization of Mn_xO_y nanofibers for improved supercapacitive properties. In Y. B. Pottathara, S. Thomas, N. Kalarikkal, Y. Grohens & V. Kokol (Eds.), *Nanomaterials Synthesis: Design, Fabrication and Applications* (pp. 451-481). Elsevier. <https://doi.org/10.1016/B978-0-12-815751-0.00013-4>
- Cappato, L. P., Ferreira, M. V. S., Guimaraes, J. T., Portela, J. B., Costa, A. L. R., Freitas, M. Q., Cunha, R. L., Oliveira, C. A. F., Mercali, G. D., Marzack, L. D. F., & Cruz, A. G. (2017). Ohmic heating in dairy processing: Relevant aspects for safety and quality. *Trends in Food Science and Technology*, *62*, 104-112. <https://doi.org/10.1016/j.tifs.2017.01.010>

- Cardona, E., Llano, B., Peñuela, M., Peña, J., & Rios, L. A. (2018). Liquid-hot-water pretreatment of palm-oil residues for ethanol production: An economic approach to the selection of the processing conditions. *Energy*, *160*, 441-451. <https://doi.org/10.1016/j.energy.2018.07.045>
- Chang, S. H. (2014). An overview of empty fruit bunch from oil palm as feedstock for bio-oil production. *Biomass and Bioenergy*, *62*, 174-181. <https://doi.org/10.1016/j.biombioe.2014.01.002>
- Conde-Mejía, C., Jiménez-Gutiérrez, A., & El-Halwagi, M. (2012). A comparison of pretreatment methods for bioethanol production from lignocellulosic materials. *Process Safety and Environmental Protection*, *90*(3), 189-202. <https://doi.org/10.1016/j.psep.2011.08.004>
- Diyanilla, R., Hamidon, T. S., Suryanegara, L., & Hussin, M. H. (2020). Overview of pretreatment methods employed on oil palm biomass in producing value-added products: A review. *BioResources*, *15*(4), 9935-9997. <https://doi.org/10.15376/biores.15.4.diyaniilla>
- Ezechi, E. H., & Muda, K. (2019). Overview of trends in crude palm oil production and economic impact in Malaysia. *Sriwijaya Journal of Environment*, *4*(1), 19-26. <https://doi.org/10.22135/sje.2019.4.1.19-26>
- Fatriasari, W., Anita, S. H., & Risanto, L. (2017). Microwave assisted acid pretreatment of oil palm empty fruit bunches (EFB) to enhance its fermentable sugar production. *Waste and Biomass Valorization*, *8*(2), 379-391. <https://doi.org/10.1007/s12649-016-9573-6>
- Gavahian, M., Farhoosh, R., Farahnaky, A., Javidna, K., & Shahidi, F. (2015). Ohmic-assisted hydrodistillation of essential oils from *Mentha piperita*. *Iranian Food Science and Technology Research Journal*, *11*(3), 236-246.
- Gavahian, M., Tiwari, B. K., Chu, Y. H., Ting, Y., & Farahnaky, A. (2019). Food texture as affected by ohmic heating: Mechanisms involved, recent findings, benefits, and limitations. *Trends in Food Science and Technology*, *86*, 328-339. <https://doi.org/10.1016/j.tifs.2019.02.022>
- Głazowska, S., Baldwin, L., Mravec, J., Bukh, C., Hansen, T. H., Jensen, M. M., Fangel, J. U., Willats, W. G. T., Glasius, M., Felby, C., & Schjoerring, J. K. (2018). The impact of silicon on cell wall composition and enzymatic saccharification of *Brachypodium distachyon*. *Biotechnology for Biofuels*, *11*, Article 171. <https://doi.org/10.1186/s13068-018-1166-0>
- Hamzah, F., Idris, A., & Sarif, M. (2020). Effect of microwave-alkali techniques on the morphology and physical changes of treated oil palm empty fruit bunches fiber. *Materials Science Forum*, *987*, 124-128. <https://doi.org/10.4028/www.scientific.net/msf.987.124>
- Hamzah, M. H., Sudin, S. S., Mutalib, T. N. A. T. A., Malek, N. F. H. A., Yusof, N., Jamaludin, H., Man, H. C., & Abidin, Z. Z. (2011). Preliminary study of ohmic heated hydro distillation for essential oil's plant extraction Malaysia. In *2011 IEEE Student Conference on Research and Development* (pp. 211-214). IEEE Publishing. <https://doi.org/10.1109/SCOReD.2011.6148737>
- Hassan, N., Tan, L. W., Anwar, N. A. K., & Idris, A. (2021). Ionic solution pretreatment of oil palm empty fruit bunch to produce sugars. *BioResources*, *16*(1), 1816-1824.
- Hassan, S. S., Williams, G. A., & Jaiswal, A. K. (2018). Emerging technologies for the pretreatment of lignocellulosic biomass. *Bioresource Technology*, *262*, 310-318. <https://doi.org/10.1016/j.biortech.2018.04.099>

- Hoekstra, A. Y., & Wiedmann, T. O. (2014). Humanity's unsustainable environmental footprint. *Science*, *344*(6188), 1114-1117. <https://doi.org/10.1126/science.1248365>
- Hu, F., & Ragauskas, A. (2012). Pretreatment and lignocellulosic chemistry. *Bioenergy Research*, *5*(4), 1043-1066. <https://doi.org/10.1007/s12155-012-9208-0>
- Hu, Y., Qin, H., Zhan, Z., Dun, Y., Zhou, Y., Peng, N., Ling, H., Liang, Y., & Zhao, S. (2016). Optimization of *Saccharomyces boulardii* production in solid-state fermentation with response surface methodology. *Biotechnology & Biotechnological Equipment*, *30*, 173-179. <https://doi.org/10.1080/13102818.2015.1086689>
- Iberahim, N. I., Jahim, J. M., Harun, S., Nor, M. T. M., & Hassan, O. (2013). Sodium hydroxide pretreatment and enzymatic hydrolysis of oil palm mesocarp fiber. *International Journal of Chemical Engineering and Applications*, *4*(3), 101-105. <https://doi.org/10.7763/ijcea.2013.v4.272>
- Indiarto, R., & Rezaharsamto, B. (2020). A review on ohmic heating and its use in food. *International Journal of Scientific & Technology Research*, *9*(2), 485-490.
- Irmak, S., Meryemoglu, B., Sandip, A., Subbiah, J., Mitchell, R. B., & Sarath, G. (2018). Microwave pretreatment effects on switchgrass and miscanthus solubilization in subcritical water and hydrolysate utilization for hydrogen production. *Biomass and Bioenergy*, *108*, 48-54. <https://doi.org/10.1016/J.BIOMBIOE.2017.10.039>
- Karunakaran, V., Abd-Talib, N., & Yong, T. L. K. (2020). Lignin from oil palm empty fruit bunches (EFB) under subcritical phenol conditions as a precursor for carbon fiber production. *Materials Today: Proceedings*, *31*, 100-105. <https://doi.org/10.1016/j.matpr.2020.01.252>
- Karunanithi, S. (2019). Optimization of process parameters of ohmic heating for improving yield and quality of tomato seed oil. *International Journal of Pure & Applied Bioscience*, *7*(3), 104-114. <https://doi.org/10.18782/2320-7051.7477>
- Khalil, H. P. S. A., Jawaid, M., Hassan, A., Paridah, M. T., & Zaido, A. (2012). Oil palm biomass fibres and recent advancement in oil palm biomass fibres based hybrid biocomposites. In N. Hu (Ed.), *Composites and Their Applications* (pp. 187-220). InTech. <https://doi.org/10.5772/48235>
- Kim, J. S., Lee, Y. Y., & Kim, T. H. (2016). A review on alkaline pretreatment technology for bioconversion of lignocellulosic biomass. *Bioresource Technology*, *199*, 42-48. <https://doi.org/10.1016/j.biortech.2015.08.085>
- Krishnan, Y., Bong, C. P. C., Azman, N. F., Zakaria, Z., Othman, N., Abdullah, N., Ho, C. S., Lee, C. T., Hansen, S. B., & Hara, H. (2017). Co-composting of palm empty fruit bunch and palm oil mill effluent: Microbial diversity and potential mitigation of greenhouse gas emission. *Journal of Cleaner Production*, *146*, 94-100. <https://doi.org/10.1016/j.jclepro.2016.08.118>
- Kumar, A. K., & Sharma, S. (2017). Recent updates on different methods of pretreatment of lignocellulosic feedstocks: A review. *Bioresources and Bioprocessing*, *4*, Article 7. <https://doi.org/10.1186/s40643-017-0137-9>
- Kutlu, N., Isci, A., Sakiyan, O., & Yilmaz, A. E. (2021). Effect of ohmic heating on ultrasound extraction of phenolic compounds from cornelian cherry (*Cornus mas*). *Journal of Food Processing and Preservation*, *45*(10), Article e15818. <https://doi.org/10.1111/jfpp.15818>

- Le, D. M., Sørensen, H. R., Knudsen, N. O., & Meyer, A. S. (2015). Implications of silica on biorefineries - interactions with organic material and mineral elements in grasses. *Biofuels, Bioproducts and Biorefining*, 9(1), 109-121. <https://doi.org/10.1002/bbb.1511>
- Lee, S. H., & Jun, S. (2011). Enhancement of sugar release from taro waste using ohmic heating and microwave heating techniques. *Transactions of the ASABE*, 54(3), 1041-1047.
- Lee, S. Y., Ryu, S., & Kang, D. H. (2013). Effect of frequency and waveform on inactivation of *Escherichia coli* O157:H7 and *Salmonella enterica* serovar typhimurium in salsa by ohmic heating. *Applied and Environmental Microbiology*, 79(1), 10-17. <https://doi.org/10.1128/AEM.01802-12>
- Lourenço, A., & Pereira, H. (2018). Compositional variability of lignin in biomass. In M. Poletto (Ed.), *Lignin - Trends and Applications* (pp. 65-98). InTech. <https://doi.org/10.5772/intechopen.71208>
- Marçal, F. A., França, L. F., & Fernandes Corrêa, N. C. (2018). Empty fruit bunch treatment. *BioResources*, 13(3), 6911-6921.
- Mohammad, I. N., Ongkudon, C. M., & Misson, M. (2020). Physicochemical properties and lignin degradation of thermal-pretreated oil palm empty fruit bunch. *Energies*, 13(22), Article 5966. <https://doi.org/10.3390/en13225966>
- Nabilah-Jansar, K., Roslan, A. M., & Hassan, M. A. (2018). Appropriate hydrothermal pretreatment of oil palm biomass in palm oil mill. *Pertanika Journal of Scholarly Research Reviews*, 4(1), 31-40. <http://pjsrr.upm.edu.my/index.php/pjsrr/article/view/119>
- Nomanbhay, S. M., Hussain, R., & Palanisamy, K. (2013). Microwave-assisted alkaline pretreatment and microwave assisted enzymatic saccharification of oil palm empty fruit bunch fiber for enhanced fermentable sugar yield. *Journal of Sustainable Bioenergy Systems*, 03(01), 7-17. <https://doi.org/10.4236/jsbs.2013.31002>
- Ozkan, G., Guldiken, B., & Capanoglu, E. (2019). Effect of novel food processing technologies on beverage antioxidants. In A. M. Grumezescu & A. M. Holban (Eds.), *Processing and Sustainability of Beverages* (pp. 413-449). Elsevier. <https://doi.org/10.1016/b978-0-12-815259-1.00012-4>
- Palamae, S., Dechatiwongse, P., Choorit, W., Chisti, Y., & Prasertsan, P. (2017). Cellulose and hemicellulose recovery from oil palm empty fruit bunch (EFB) fibers and production of sugars from the fibers. *Carbohydrate Polymers*, 155, 491-497. <https://doi.org/10.1016/j.carbpol.2016.09.004>
- Panigrahi, S., & Dubey, B. K. (2019). Electrochemical pretreatment of yard waste to improve biogas production: Understanding the mechanism of delignification, and energy balance. *Bioresource Technology*, 292, Article 121958. <https://doi.org/10.1016/j.biortech.2019.121958>
- Panigrahi, S., Sharma, H. B., Tiwari, B. R., Krishna, N. V., Ghangrekar, M. M., & Dubey, B. K. (2021). Insight into understanding the performance of electrochemical pretreatment on improving anaerobic biodegradability of yard waste. *Renewable Energy*, 180, 1166-1178. <https://doi.org/10.1016/j.renene.2021.08.123>
- Pare, A., Nema, A., Singh, V. K., & Mandhyan, B. L. (2014). Combined effect of ohmic heating and enzyme assisted aqueous extraction process on soy oil recovery. *Journal of Food Science and Technology*, 51(8), 1606-1611. <https://doi.org/10.1007/s13197-012-0685-0>

- Perasiriyana, V., Priya, S., Gowri, A. M., Ramasamy, D., & Sivakumar, T. (2016). Design and evaluation of electrical resistance unit (ohmic heating) for food processing. *International Research Journal of Engineering and Technology*, 3, 1357-1361.
- Pereira, R. N., Rodrigues, R. M., Genisheva, Z., Oliveira, H., de Freitas, V., Teixeira, J. A., & Vicente, A. A. (2016). Effects of ohmic heating on extraction of food-grade phytochemicals from colored potato. *LWT*, 74, 493-503. <https://doi.org/10.1016/j.lwt.2016.07.074>
- Picart-Palmade, L., Cunault, C., Chevalier-Lucia, D., Belleville, M. P., & Marchesseau, S. (2019). Potentialities and limits of some non-thermal technologies to improve sustainability of food processing. *Frontiers in Nutrition*, 5, Article 130. <https://doi.org/10.3389/fnut.2018.00130>
- Pires, R. P. S., Cappato, L. P., Guimarães, J. T., Rocha, R. S., Silva, R., Balthazar, C. F., Freitas, M. Q., Silva, P. H. F., Neto, R. P. C., Tavares, M. I. B., Granato, D., Raices, R. S. L., Silva, M. C., & Cruz, A. G. (2020). Ohmic heating for infant formula processing: Evaluating the effect of different voltage gradient. *Journal of Food Engineering*, 280, Article 109989. <https://doi.org/10.1016/j.jfoodeng.2020.109989>
- Rinaldi, M., Littardi, P., Paciulli, M., Ganino, T., Cocconi, E., Barbanti, D., Rodolfi, M., Aldini, A., & Chiavaro, E. (2020). Impact of ohmic heating and high pressure processing on qualitative attributes of ohmic treated peach cubes in syrup. *Foods*, 9(8), Article 1093. <https://doi.org/10.3390/foods9081093>
- Ríos-Ríos, K. L., Gaytán-Martínez, M., Rivera-Pastrana, D. M., Morales-Sánchez, E., Villamiel, M., Montilla, A., Mercado-Silva, E. M., & Vázquez-Barrios, M. E. (2021). Ohmic heating pretreatment accelerates black garlic processing. *LWT*, 151, Article 112218. <https://doi.org/10.1016/j.lwt.2021.112218>
- Rocheffort, D., Leech, D., & Bourbonnais, R. (2004). Electron transfer mediator systems for bleaching of paper pulp. *Green Chemistry*, 6(1), 14-24. <https://doi.org/10.1039/b311898n>
- Rodríguez, L. M. N., Arias, R., Soteras, T., Sancho, A., Pesquero, N., Rossetti, L., Tacca, H., Aimaretti, N., Cervantes, M. L. R., & Szerman, N. (2021). Comparison of the quality attributes of carrot juice pasteurized by ohmic heating and conventional heat treatment. *LWT*, 145, Article 111255. <https://doi.org/10.1016/j.lwt.2021.111255>
- Sakr, M., & Liu, S. (2014). A comprehensive review on applications of ohmic heating (OH). *Renewable and Sustainable Energy Reviews*, 39, 262-269. <https://doi.org/10.1016/j.rser.2014.07.061>
- Sastry, S. (2008). Ohmic heating and moderate electric field processing. *Food Science and Technology International*, 14(5), 419-422. <https://doi.org/10.1177/1082013208098813>
- Sengun, I. Y., Yildiz Turp, G., Icier, F., Kendirci, P., & Kor, G. (2014). Effects of ohmic heating for pre-cooking of meatballs on some quality and safety attributes. *LWT*, 55(1), 232-239. <https://doi.org/10.1016/j.lwt.2013.08.005>
- Shim, J. Y., Lee, S. H., & Jun, S. (2010). Modeling of ohmic heating patterns of multiphase food products using computational fluid dynamics codes. *Journal of Food Engineering*, 99(2), 136-141. <https://doi.org/10.1016/j.jfoodeng.2010.02.009>
- Simanungkalit, S. P., Mansur, D., Nurhakim, B., Agustin, A., Rinaldi, N., Muryanto, & Fitriady, M. A. (2017). Hydrothermal pretreatment of palm oil empty fruit bunch. *AIP Conference Proceedings*, 1803(1), Article 020011. <https://doi.org/10.1063/1.4973138>

- Sofi'I, I., Arifin, Z., & Oktafrina. (2021). Energy Consumption for Patchouli Oil Extraction Using Ohmic Heating. *IOP Conference Series: Earth and Environmental Science*, 1012(1), Article 012062. <https://doi.org/10.1088/1755-1315/1012/1/012062>
- Sun, S., Sun, S., Cao, X., & Sun, R. (2016). The role of pretreatment in improving the enzymatic hydrolysis of lignocellulosic materials. *Bioresource Technology*, 199, 49-58. Elsevier Ltd. <https://doi.org/10.1016/j.biortech.2015.08.061>
- Sun, W., Greaves, T. L., & Othman, M. Z. (2020). Electro-assisted pretreatment of lignocellulosic materials in ionic liquid-promoted organic solvents. *ACS Sustainable Chemistry and Engineering*, 8(49), 18177-18186. <https://doi.org/10.1021/acssuschemeng.0c06537>
- Tamburini, E., Bernardi, T., Castaldelli, G., Tumiatti, G., & Ferro, S. (2011). Green electrochemical approach for delignification of wheat straw in second-generation bioethanol production. *Energy and Environmental Science*, 4(2), 551-557. <https://doi.org/10.1039/c0ee00226g>
- TAPPI. (1950). *T.A.P.P.I. Standards: Testing Methods, Recommended Practices, Specifications of the Technical Association of the Pulp and Paper Industry*. Technical Association of the Pulp and Paper Industry.
- Tarasov, D., Leitch, M., & Fatehi, P. (2018). Lignin-carbohydrate complexes: Properties, applications, analyses, and methods of extraction: A review. *Biotechnology for Biofuels*, 11(1), 1-28. <https://doi.org/10.1186/s13068-018-1262-1>
- Timsit, R. S., & Luttgen, A. (2016). Temperature distribution in an ohmic-heated electrical contact at high signal frequencies. *Applied Physics Letters*, 108(12), Article 121603. <https://doi.org/10.1063/1.4944535>
- Tunç, M. T., & Koca, İ. (2021). Optimization of ohmic heating assisted hydrodistillation of cinnamon and bay leaf essential oil. *Journal of Food Process Engineering*, 44(3), Article e13635. <https://doi.org/10.1111/jfpe.13635>
- Ummalyma, S. B., Supriya, R. D., Sindhu, R., Binod, P., Nair, R. B., Pandey, A., & Gnansounou, E. (2019). Biological pretreatment of lignocellulosic biomass-current trends and future perspectives. In A. Basile & F. Dalena (Eds.), *Second and Third Generation of Feedstocks: The Evolution of Biofuels* (pp. 197-212). Elsevier Inc. <https://doi.org/10.1016/B978-0-12-815162-4.00007-0>
- Varga, E., Schmidt, A. S., Réczey, K., & Thomsen, A. B. (2003). Pretreatment of corn stover using wet oxidation to enhance enzymatic digestibility. *Applied Biochemistry and Biotechnology - Part A Enzyme Engineering and Biotechnology*, 104(1), 37-50. <https://doi.org/10.1385/ABAB:104:1:37>
- Wadchasit, P., Siripattana, C., & Nuithitikul, K. (2020). The effect of pretreatment methods for improved biogas production from oil-palm empty fruit bunches (EFB): Experimental and model. *IOP Conference Series: Earth and Environmental Science*, 463, Article 012126. <https://doi.org/10.1088/1755-1315/463/1/012126>
- Wang, C., Llave, Y., Sakai, N., & Fukuoka, M. (2021). Analysis of thermal processing of liquid eggs using a high frequency ohmic heating: Experimental and computer simulation approaches. *Innovative Food Science and Emerging Technologies*, 73, Article 102792. <https://doi.org/10.1016/j.ifset.2021.102792>
- Xu, J., Cheng, J. J., Sharma-Shivappa, R. R., & Burns, J. C. (2010). Sodium hydroxide pretreatment of switchgrass for ethanol production. *Energy and Fuels*, 24(3), 2113-2119. <https://doi.org/10.1021/ef9014718>

- Yaser, A. Z., Jananun, J., Chong, K. P., & Haywood, S. K. (2017). Effect of pre-treatment and inoculant during composting of palm oil empty fruit bunches. *ASEAN Journal of Chemical Engineering*, 17(2), 1-16. <https://doi.org/10.22146/ajche.49551>
- Yimlamai, B., Choorit, W., Chisti, Y., & Prasertsan, P. (2021). Cellulose from oil palm empty fruit bunch fiber and its conversion to carboxymethylcellulose. *Journal of Chemical Technology and Biotechnology*, 96(6), 1656-1666. <https://doi.org/10.1002/jctb.6689>
- Ying, T. Y., Teong, L. K., Abdullah, W. N. W., & Peng, L. C. (2014). The effect of various pretreatment methods on oil palm empty fruit bunch (EFB) and kenaf core fibers for sugar production. *Procedia Environmental Sciences*, 20, 328-335. <https://doi.org/10.1016/j.proenv.2014.03.041>
- Zhai, R., Hu, J., & Saddler, J. N. (2018). Minimizing cellulase inhibition of whole slurry biomass hydrolysis through the addition of carbocation scavengers during acid-catalyzed pretreatment. *Bioresource Technology*, 258, 12-17. <https://doi.org/10.1016/j.biortech.2018.02.124>
- Zhao, Y., Wang, Y., Zhu, J. Y., Ragauskas, A., & Deng, Y. (2008). Enhanced enzymatic hydrolysis of spruce by alkaline pretreatment at low temperature. *Biotechnology and Bioengineering*, 99(6), 1320-1328. <https://doi.org/10.1002/bit.21712>
- Zhuykov, S. (2018). Semiconductor nano-crystals in environmental sensors. In S. Zhuykov (Ed.), *Nanostructured Semiconductors* (pp. 475-538). Elsevier Ltd. <https://doi.org/10.1016/b978-0-08-101919-1.00009-x>

